

VARIOS DE PASAJE:

No. DE PARTE 574
REPUESTO PARA PARO DE MOTOR
TIPO KNORR-BREMSE AE 1206

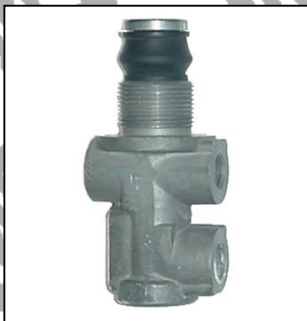

No. DE PARTE 325
REPUESTO PARA VALVULA
REGULADORA
TIPO SCHRADER BOLLOWS
No. 3560 2000

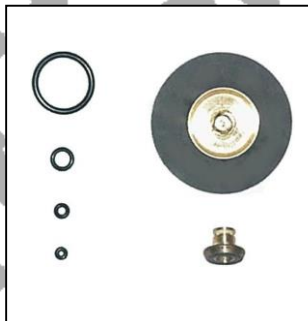

No. DE PARTE 528
REPUESTO PARA BLOQUEADOR
TIPO KNORR-BREMSE BZ1616
RETEN DIAMETRO INT: 2660 "
DIAM: 125MM



No. DE PARTE 893
GUÁRDAPOLVO PARA
BLOQUEADOR
TIPO KNORR-BREMSE BZ1616



No. DE PARTE 552
REPUESTO PARA BLOQUEADOR
TIPO KNORR-BREMSE BZ1616
RETEN DIAMETRO INT: 3150 "
DIAM: 125MM



No. DE PARTE 986
REPUESTO PARA VALVULA HIDRAULICA
DE MANDO DEL TERCER EJE
1800 ZF LENKSYSTEME
150 BAR 003078 GERMANY 8353 900 101

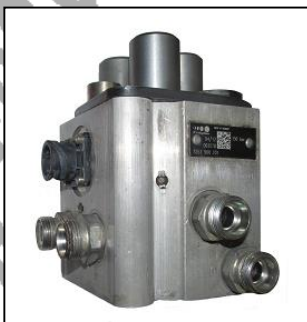
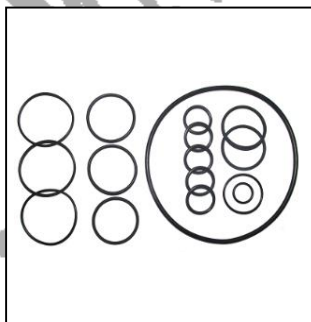

VARIOS DE PASAJE:

No. DE PARTE 382

REPUESTO PARA LIMPIABRISAS

TIPO CPV AM-1081 4" 70-IZQ CQ

21.150-110 MANUFACTURADO EN BRASIL

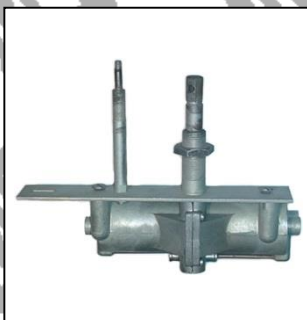
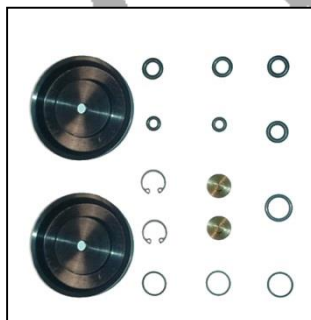

No. DE PARTE 538

REPUESTO PARA MANGUERA

SERVO-TRANSMISION

AUTOBUS OC500

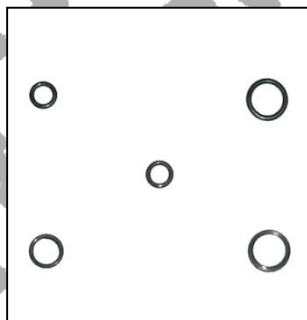

No. DE PARTE 987

GUARDAPOLVO PARA BARRA CARDAN DE DIRECCION

DIAMETRO MAYOR DE BARRA: 1.655"

DIAMETRO MAYOR DE ASTRIADO: 1.220"



No. DE PARTE 989

GUARDAPOLVO PARA BARRA CARDAN DE EJE

DIAMETRO MAYOR DE BARRA: 1.615"



VARIOS DE PASAJE:

No. DE PARTE 991
REPUESTO PARA ENFRIADOR
DE SPRINTER

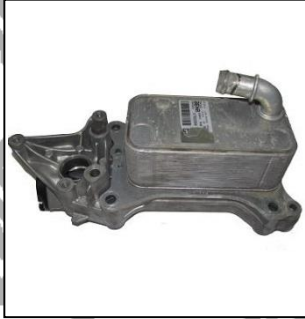
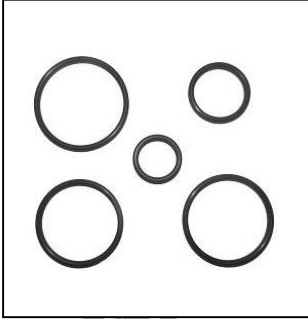

No. DE PARTE 993
GUARDAPOLVO PARA CAMARA
SENCILLA DELANTERA T-24
PARA AUTOBUS



No. DE PARTE 726
EMPAQUE PARA
BOMBA DE AGUA
TIPO SCANIA 551355
ALTURA 0.164"

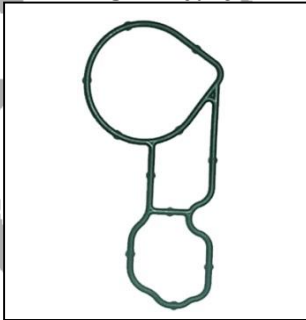

No. DE PARTE 766
EMPAQUE PARA
BOMBA DE AGUA
TIPO SCANIA 551355
ALTURA 0.195"

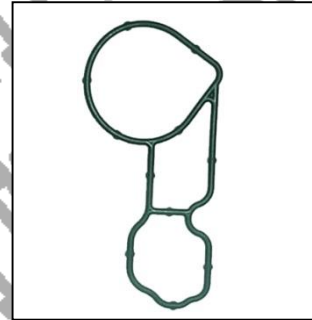

No. DE PARTE 470
PAR DE EMPAQUES PARA RADIADOR
TIPO SCANIA

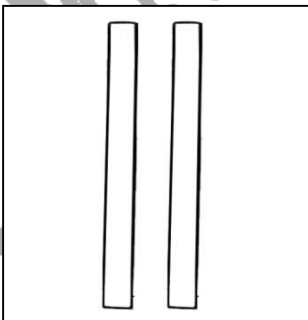

No. DE PARTE 571 T- 9
No. DE PARTE 550 T-12
No. DE PARTE 551 T-16
No. DE PARTE 581 T-24
No. DE PARTE 655 T-50



VARIOS DE PASAJE:

No. DE PARTE 592
GUARDAPOLVO
PARA MORDAZA
AUTOBUS MAN



No. DE PARTE 646
GUARDAPOLVO PARA
MORDAZA
TIPO DSL 13 68321674
IRIZAR

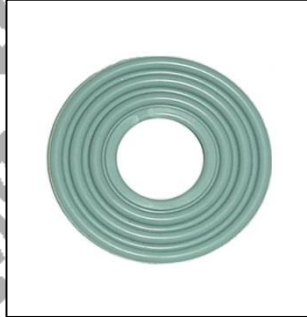

No. DE PARTE 711
GUARDAPOLVO
INTERIOR
PARA FRENO DE DISCO
TIPO VOLVO 9700



No. DE PARTE 712
GUARDAPOLVO
EXTERIOR
PARA FRENO DE DISCO
TIPO VOLVO 9700



No. DE PARTE 602
GUARDAPOLVO PARA
ROTACHAMBERS
DELANTEROS DE
DIAFRAGMAS CONICOS



No. DE PARTE 778
GUARDAPOLVO PARA BRAZO TRASERO
DE BARRA ESTABILIZADORA MULTEGO



No. DE PARTE 616
GUARDAPOLVO
PARA PISTON
TIPO BMP DE 2 1/2"

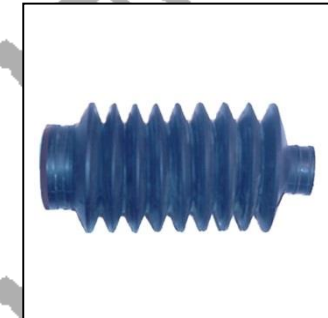

No. DE PARTE 961
GUAARDAPOLVO PARA
AJUSTADOR DE FRENOS
DE MORDAZA AUTOBUS
MULTEGO



No. DE PARTE 962
GUARDAPOLVO PARA
BARRA DE
ACOPLAMIENTO
MERCEDES 1800

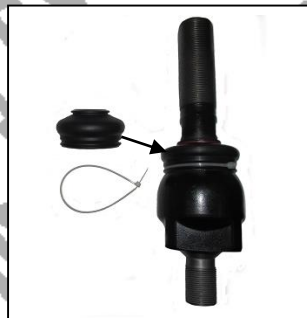

No. DE PARTE 963
REPUESTO PARA VALVULA INVERSORA
TIPO KNORR-BREMSE 02074
SDP12 GA AUTOBUS VOLVO 7550
DGM 7363FC MAGNETI MARELLI ITALIANA

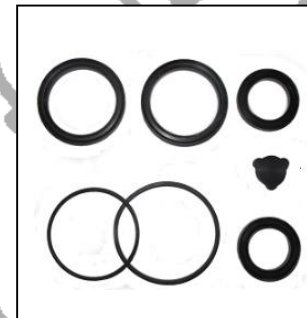

VARIOS DE PASAJE:

No. DE PARTE 614
REPUESTO PARA VALVULA CHECK
TIPO KNORR-BREMSE AE 5115
BOLSA CON 5 PZS

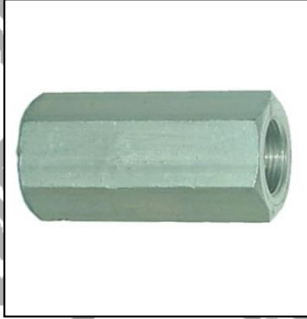

No. DE PARTE 659
REPUESTO PARA
FAN CLUTCH HORTON
MCI MENOR

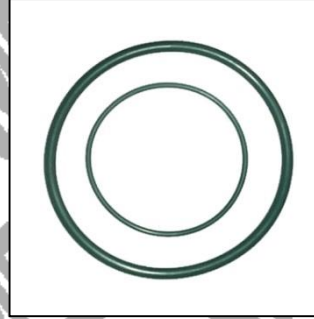

No. DE PARTE 681
EMPAQUE PARA TAPON DE DIESEL
TANQUE DE ALUMINIO MERCEDES
O-400 y O-500

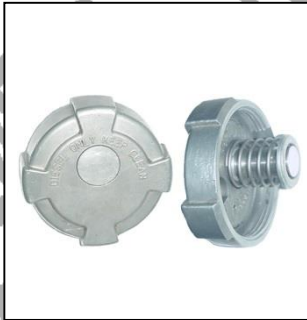
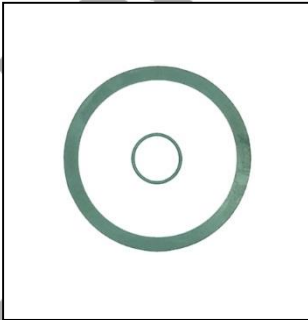

No. DE PARTE 803
EMPAQUE PARA TAPON DE DIESEL
DE AUTOBUS TIPO VOLVO

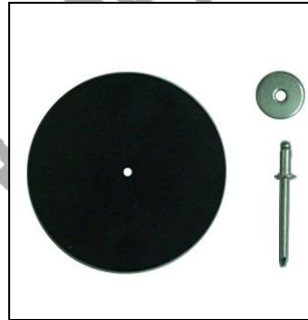

No. DE PARTE 260
REPUESTO PARA VALVULA
DE RETENCION
TIPO MTY

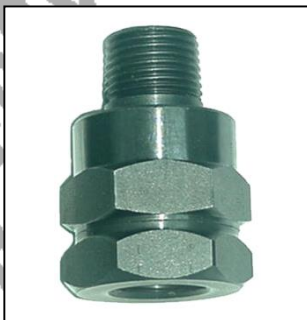

No. DE PARTE 1000
VALVULA DE RETENCION
(CHECK) MTY

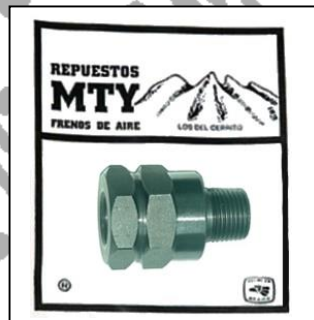

VARIOS DE PASAJE:

No. DE PARTE 837
CUBRE TUERCA
PARA BRAZO
DE LIMPIADOR



No. DE PARTE 831
LIGA PARA FLECHA
DE LIMPIADOR
TIPO DOGA
5 PZS

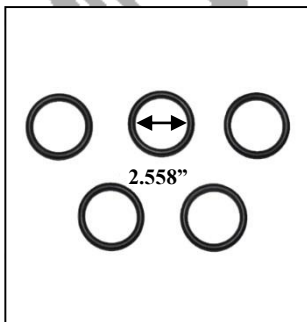

No. DE PARTE 557
REPUESTO PARA INYECTOR
TIPO SCANIA

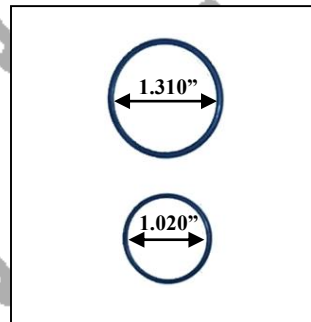

No. DE PARTE 556
SELLO COMPRESOR
CLIMA 05K

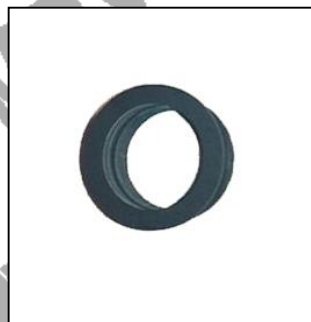

No. DE PARTE 576
PAR DE LIGAS PARA TURBO
TIPO 20742476 VOLVO 7550
TIPO 1052358 B VOLVO 9700
712922-9

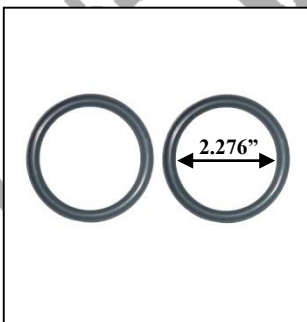

No. DE PARTE 1022
GUARDAPOLVO PARA
CREMALLERA AUTOBUS
MERCEDES BENZ 1800



No. DE PARTE 603
REPUESTO PARA TAPA DE
TORRE DE CAMBIOS
TIPO 3316416



No. DE PARTE 720
REPUESTO DE BASE PARA SENSORES
DE CAJA DE VELOCIDADES
TIPO SCANIA

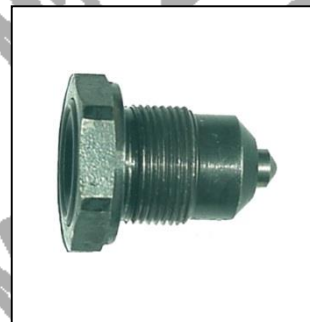
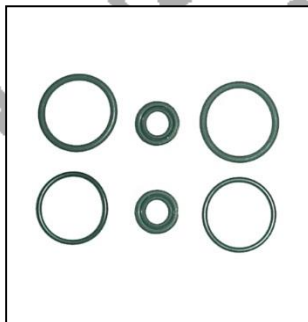
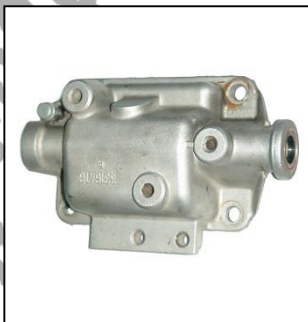

VARIOS DE PASAJE:

No. DE PARTE 636
REPUESTO PARA VALVULA
TIPO SCANIA 1726573

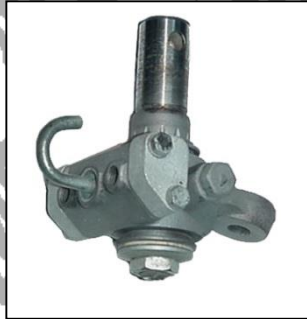

No. DE PARTE 660
REPUESTO PARA VALVULA DE PASO
TIPO PALANCA FNA 5575.1

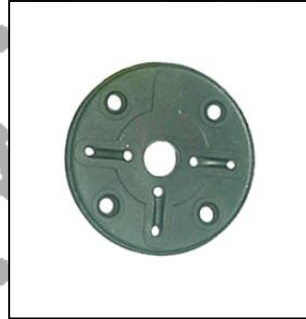

No. DE PARTE 729
ENGRANE No. 1 PARA
ODOMETRO
TIPO VOLVO



No. DE PARTE 787
ENGRANE PARA ODOMETRO
MOTOMETER TIPO VTC3171906
PARA VOLVOS 7550 Y 9300



No. DE PARTE 865
TAPON PARA DEPOSITO
DE AGUA PARA LIMPIAPARABRISAS



No. DE PARTE 838
LIGA PARA CONEXIÓN
TIPO CODO

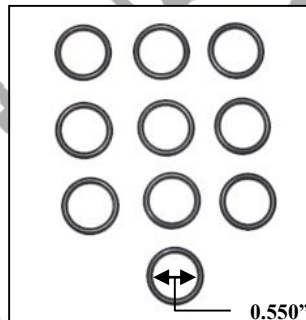

VARIOS DE PASAJE:

No. DE PARTE 675
LIGA PARA CONEXION RAPIDA
BOLSA CON 10 PIEZAS

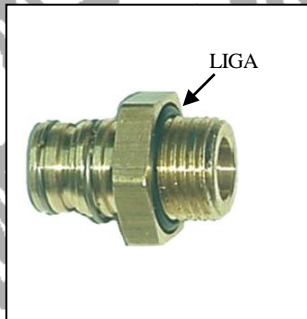
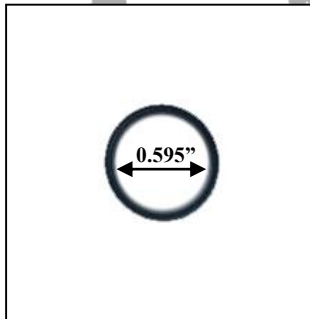

No. DE PARTE 676
LIGA PARA CONEXION DE 22 MM A 16 MM
BOLSA CON 10 PIEZAS

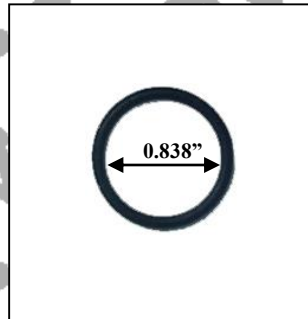

No. DE PARTE 708
REPUESTO PARA
FILTRO DE ACEITE
DE TRANSMISION
TIPO VOLVO 9700

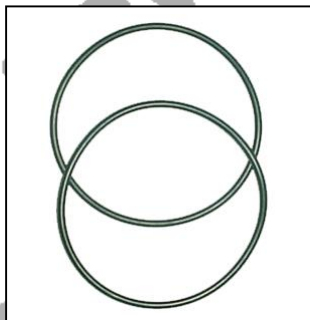

No. DE PARTE 732
TORNILLO LIBERADOR
PARA CAMARA DE AIRE
TIPO WABCO

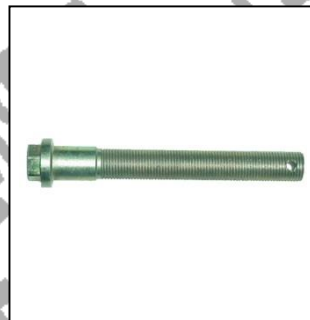

No. DE PARTE 584
REPUESTO PARA CILINDRO HAUSING
DE PALANCA DE CAMBIOS AUTOBUS
TIPO 1669222 VOLVO 7550 Y 9700

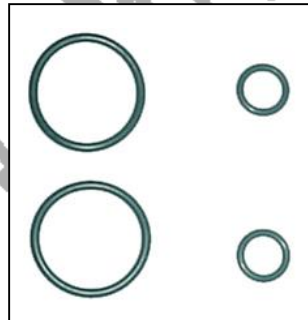

No. DE PARTE 753
REPUESTO PARA PALANCA DE CAMBIOS
TIPO MULTEGO 6038.002.029

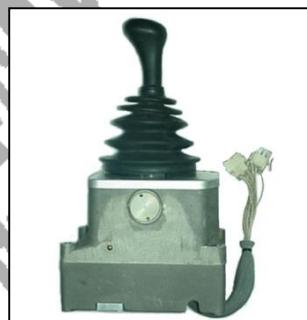
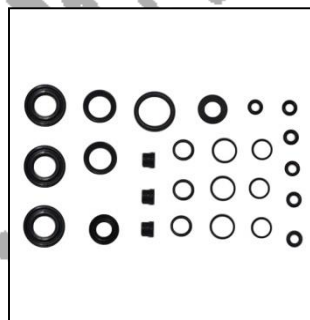

No. DE PARTE 765
GUARDAPOLVO PARA PALANCA
DE CAMBIOS
TIPO MULTEGO



VARIOS DE PASAJE:

No. DE PARTE 758
REPUESTO PARA ELECTROVALVULA MACMAN
PARA CILINDRO DE PALANCA DE CAMBIOS
TIPO VOLVO 1614330

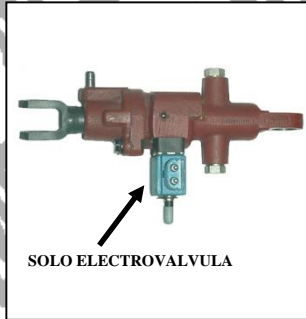
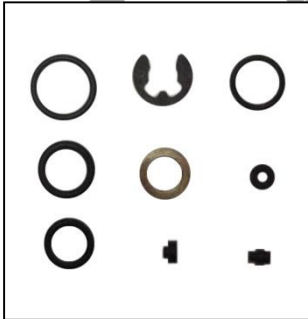

No. DE PARTE 763
GUARDAPOLVO PARA PINZA DE FRENO
TIPO MULTEGO

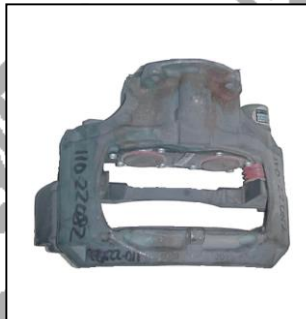
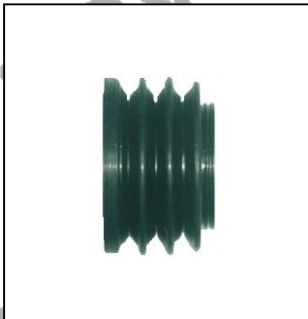

No. DE PARTE 780
EMPAQUE PARA TAPA DE ENFRIADOR
DE ACEITE PARA MOTORES
MERCEDES 906 Y 904

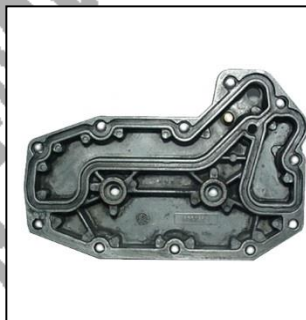
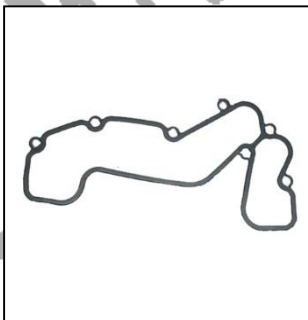

No. DE PARTE 480
LIGA PARA ENFRIADOR DE ACEITE
DE MOTOR
TIPO SCANIA 1502798

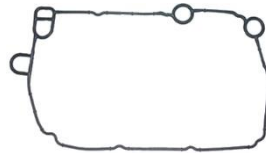

No. DE PARTE 777
LIGAS PARA TAPAS DE
ENFRIADOR DE ACEITE

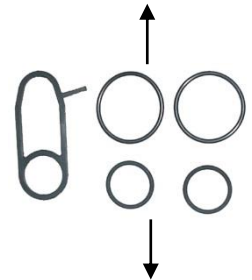

No. DE PARTE 799
EMPAQUE PARA TAPA DE ENFRIADOR DE
ACEITE CON 14 AGUJEROS

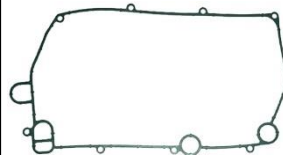

No. DE PARTE 735
PAR DE LIGAS
COMPLEMENTO
DE REPUESTO PARA
RETARDADOR VOITH 115

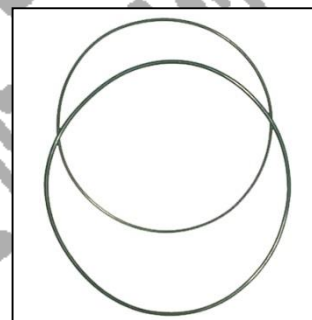

VARIOS DE PASAJE:

No. DE PARTE 790
JUEGO DE TAPONES PARA
TAPA DE PLAFONES
TIPO VOLVO



No. DE PARTE 791
JUEGO DE TAPONES
CLAROS PARA SWITCH
DE LUZ DE LECTURA



No. DE PARTE 805
JUEGO DE TAPONES
OSCUROS PARA SWITCH
DE LUZ DE LECTURA



No. DE PARTE 750
AJUSTADOR PLASTICO
PARA FAROS
TIPO VOLVO



No. DE PARTE 830
JUEGO DE TAPONES (4) TAPAPIJAS
PARA PLAFON TIPO VOLVO COLOR BEIGE

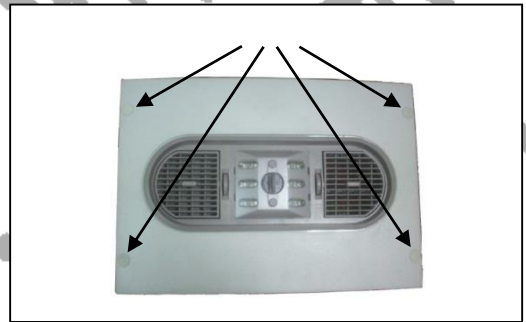

No. DE PARTE 854
REPUESTO PARA PISTON
ELECTRONEUMATICO TIPO
REXROTH MECMAN

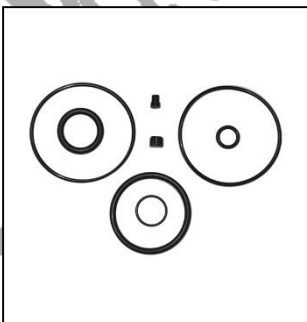

No. DE PARTE 861
REPUESTO DE MIRILLA PARA
TANQUE DE DIESEL

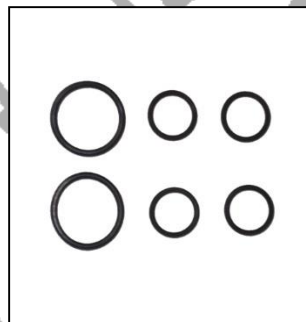

VARIOS DE PASAJE:

No. DE PARTE 10002
DIFUSOR O REJILLA
TIPO VOLVO FL 9700



No. DE PARTE 896
LIGA PARA SENSOR DE TURBO
TIPO 20912144 VOLVO 9700

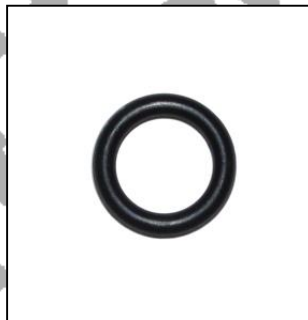

No. DE PARTE 897
LIGA PARA FLOTADOR
DE TANQUE DE
DIESEL MULTEGO FL



No. DE PARTE 810
EMPAQUE
PARA CLIMA

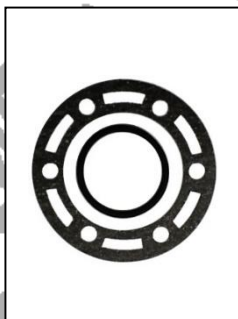

No. DE PARTE 1053
SELLO DE
LUBRICACION
PARA COMPRESOR
DETROIT DIESEL
DD13/DD15



No. DE PARTE 921
RETENES PARA CONEXIONES
MILIMETRICAS (15 PZS)
EXT: 16mm INT: 10,30mm

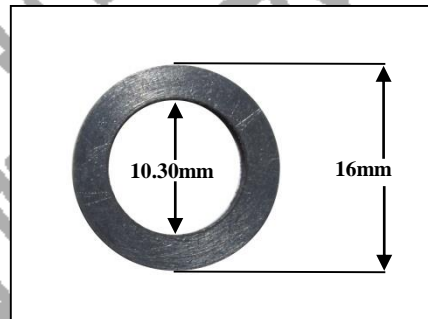

No. DE PARTE 937
RETENES PARA CONEXIONES
MILIMETRICAS (15 PZS)
EXT: 10mm INT: 5mm

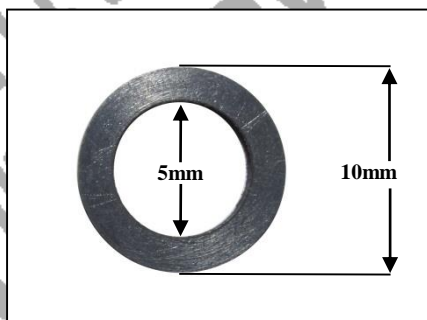

No. DE PARTE 10003
TAPA DE PERILLA PARA PALANCA
DE CAMBIOS
TIPO MERCEDES

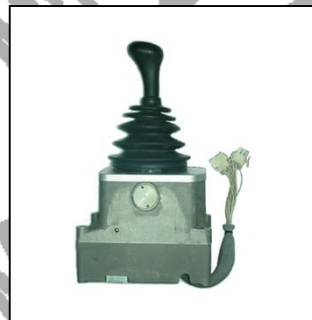
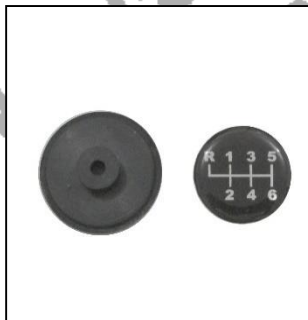

VARIOS DE PASAJE:

No. DE PARTE 929

REPUESTO PARA VALVULA DOBLE
CHECK

TIPO WABCO 008 3114 3/1 434 208 019 0



No. DE PARTE 1045

REPUESTO PARA VALVULA DOBLE CHECK
TIPO KNORR-BREMSE AE 4259 BOCHOBUS



No. DE PARTE 1015

REPUESTO PARA REGULADOR DE
PRESION FISHER
TIPO 67CR-206/TV



No. DE PARTE 1027

REPUESTO PARA ELECTROVALVULA
TIPO NORGREN EGR No. 4088562 MENOR

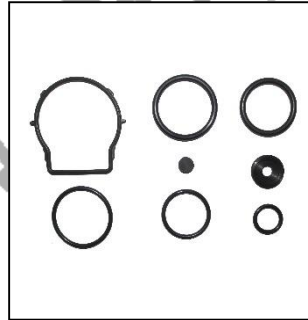

No. DE PARTE 1028

REPUESTO PARA VALVULA 3 BOBINAS
TIPO SCANIA No. 4088535 MENOR
SCANIA i5

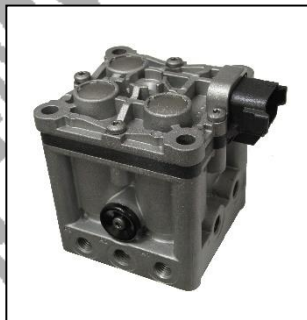
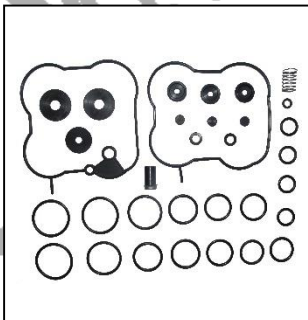

No. DE PARTE 1033

EMPAQUE DE ADMISION PARA CABEZA
DE COMPRESORES
TIPO VOLVO

